

"LHR-B" LOW WITH BACK MOUNTED SPRINGS

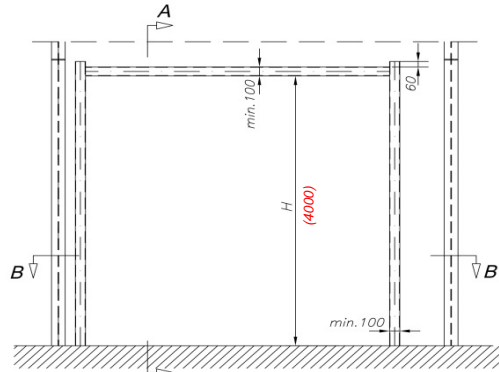

VIEW FROM INSIDE

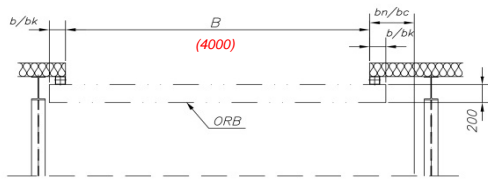

CROSS SECTION B-B

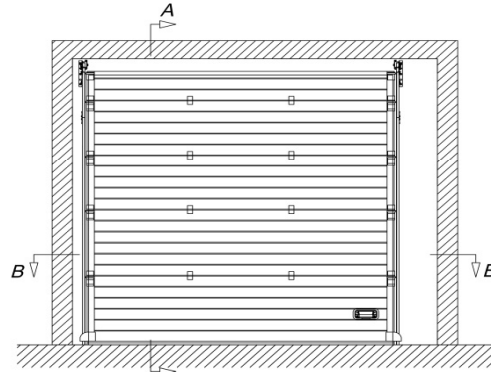

VIEW FROM INSIDE

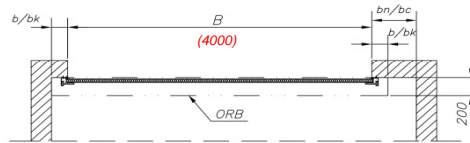

CROSS SECTION B-B

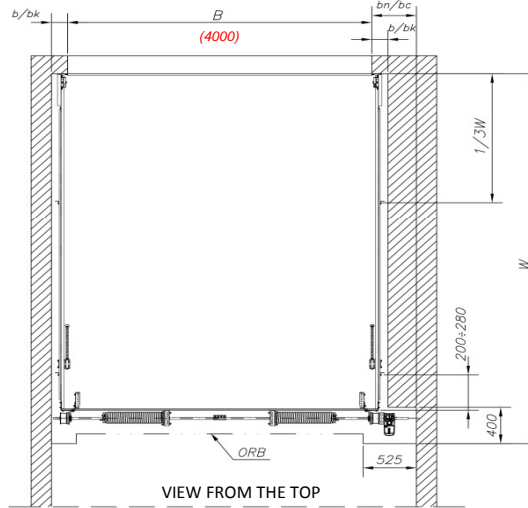

VIEW FROM THE TOP

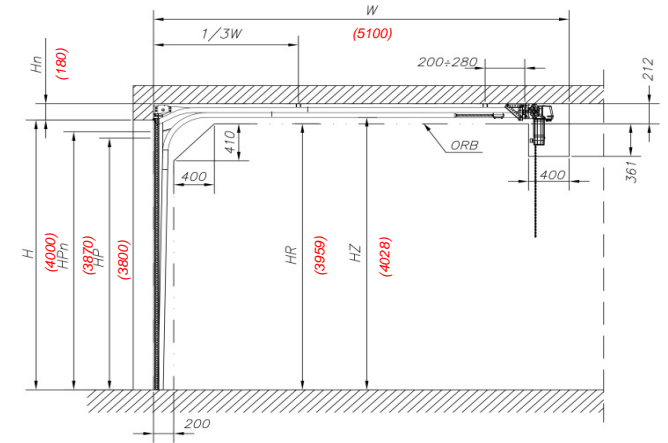

CROSS SECTION A-A

DESCRIPTION OF DIMENSIONS:

- ORB - workspace of the door
- B - opening width
- H - opening height
- Hn - headroom height
- bk - sideroom width with mounting bracket
- b min - sideroom width including perforated angles
- bc - sideroom width on chain mechanism side
- bn - sideroom width on drive side
- HP - passage height in the hand-operated door
- HP+n - passage height in door with drive
- HR - workheight
- HZ - height from the floor to the bottom edge of horizontal guide
- W - built-in depth (hand-operated door)
- Q - curtain's weight [kg/m²]
- P - area of door's curtain [m²]

1. The doors are produced to sizes according to actual pricelist KRISPOL.
2. To adjust the picture to selected size it needs to be accordingly enlarged/reduced.
3. The exact value of Wn by using different types of drives according to actual Krispol price
4. Application of the relevant product is a prerequisite for its proper functioning.
5. To select the optimal solution, please contact your representative of Krispol company --->>> www.krispol.eu

SYMBOL	SIZE LIMIT [mm]	DIMENSIONS ON THE DRAWING [mm]
B	max.8000	4000
H	max.5000	4000
Hn	min.180/max.245	180
bk	min.160	160
b min	min.160	160
bc	min.280	280
bn	min.440	440
HP	H-200	3800
HPn	H-130	3870
HR	H-41	3959
HZ	H+28	4028
W	H+1100	5100
P Q	K2 IS P=max.20 [m ²]	Q=max.13 [kg/m ²]
	K2 IM P=max.20 [m ²]	Q=max.13 [kg/m ²]
	K2 IP P=max.20 [m ²]	Q=max.13 [kg/m ²]
	K2 IA P=max.20 [m ²]	Q=max.7 [kg/m ²]
		16,00 [m ²]
		208,0 [kg]
		112,0 [kg]



KRISPOL Sp. z o.o.
ul. Budowlana 1
Psary Małe, 62-300 Września

INDUSTRIAL SECTIONAL DOOR

"LHR-B" LOW WITH BACK MOUNTED SPRINGS

Format	A3	Scale	1:50	Type	K2 I	Drawing No	XYZ_K2IS_LHR_4000x4000_2018-8-7
--------	----	-------	------	------	------	------------	---------------------------------